

M-AUDIO

Session KeyStudio
User Guide



Table of Contents

Introduction	3
Session KeyStudio Features	3
Keyboard	3
Micro USB Audio Interface	3
Session Software	3
What's in the Box?	4
About this Guide	4
Minimum System Requirements	4
Installation and Setup	5
1. Connect the KeyStudio Keyboard.	5
2. Install the Session Music Creation Software.	6
3. Connect the M-Audio Micro USB Audio Interface.	6
Getting Started Making Music with Session	7
The KeyStudio Keyboard	11
Key Names	11
Octave Buttons	11
Pitch Bend Wheel	11
Modulation Wheel	11
Volume Slider	11
Sustain Pedal Jack	11
Advanced KeyStudio Features in Edit Mode	12
Advanced Functions in Edit Mode	12
Octave Buttons Options	13
Other Assignable Controllers on KeyStudio	16
The Modulation Wheel	16
The Volume Slider	16
MIDI Messages In-Depth	17
Program & Bank Changes	17
NRPN/RPNs	18
Troubleshooting	18
Useful MIDI-specific Troubleshooting Features	21
All Notes Off	21
Reset All Controllers	21
Warranty Terms and Registration	21
Warranty Terms	21
Warranty Registration	21
Technical Info	22
Appendices - Useful MIDI Data	23
Appendix A - General MIDI Instruments	23
Appendix B - Standard MIDI Controller Numbers (MIDI CC's)	24
Appendix C - Additional RPN Messages	25

Introduction

1

Congratulations on your purchase of the M-Audio Session KeyStudio: a 49-note full size, velocity sensitive USB keyboard, audio interface, and software package designed for easy integration with your PC computer. Ideal for a multitude of music creation applications, Session KeyStudio provides you with all you and your computer need to compose great music.

NOTE: *Session KeyStudio is a software and hardware combination designed for Windows XP. However, the KeyStudio USB keyboard also works seamlessly on Apple computers that are qualified to run GarageBand. The keyboard will be ready for use immediately after connecting.*

Session KeyStudio Features

2

Keyboard:

- 49-key velocity sensitive keyboard
- Pitch Bend and Modulation wheels
- MIDI re-assignable Volume slider
- MIDI re-assignable Octave up/down buttons
- Edit Mode button for advanced functions and programming
- Sustain foot pedal input
- no driver installation needed – simply connect and power on
- bus-powered through USB

Micro USB Audio Interface:

- seamless Session KeyStudio compatibility
- low latency performance through ASIO driver architecture
- 1/8" stereo input for instruments, microphones, or line level devices
- 1/8" stereo output for headphones, powered monitors, or other devices with line level inputs
- bus-powered through USB

Session Software:

- CD-quality multi-track audio and MIDI recording software
- built-in studio quality effects
- built-in virtual synthesizer with hundreds of instrument sounds
- includes over 3.5 GB of content for professional music creation

What's in the Box?

3

Your M-Audio Session KeyStudio bundle should contain the following items:

- M-Audio KeyStudio USB keyboard
- M-Audio Micro USB audio interface
- M-Audio Session DVD-ROM
- USB cable
- Printed Session KeyStudio Quick Start Guide

If any of the above listed items are missing, please contact the retailer where you purchased the product.

About this Guide

4

This User Guide covers setup and features of the KeyStudio USB keyboard, installation of your Session music-creation software, and setup of the M-Audio Micro USB audio interface. Even if you are experienced with MIDI and PC-based music production, we still recommend reading this User Guide to help you get the most out of Session KeyStudio. The hardware contained in the bundle can also be used with third-party music software. See the documentation associated with your third-party software for more information on this.

Minimum System Requirements

5

Windows*

- Windows XP (SP2 or higher)*
- Pentium 4 1.6 GHz processor with 512MB RAM
- 4GB free HD space for complete installation
- DVD drive
- AGP 4X or faster graphics; 32MB video RAM
- 2 native USB ports

Keyboard Only:

Macintosh Minimum System Requirements

Macintosh*

- Macintosh G3 800/G4 733 MHz or higher**
(CPU may be higher for laptops)
- OS X 10.3.9 with 256 MB RAM or
OS X 10.4.2 or greater with 512 MB RAM
- One native USB port

**G3/G4 accelerator cards are not supported.

*Home and Professional Edition only. Windows Media Center Edition is not currently supported.

Installation and Setup

6

It is important that installation and setup take place in the following sequence:

1. Connect the KeyStudio Keyboard.

The KeyStudio USB keyboard is class-compliant. This means that you may simply connect the provided USB cable between KeyStudio and your Windows XP computer and switch the keyboard on. Additional drivers are not mandatory for normal operation.

As you become more familiar with the KeyStudio USB keyboard, you may wish to take advantage of this product's professional features such as: using your new keyboard with more than one application at the same time (multi-client) or sending advanced MIDI messages using KeyStudio's Edit mode. For this, M-Audio recommends installing the additional drivers found at www.m-audio.com.

PLEASE NOTE: If you are installing the optional drivers for KeyStudio, disconnect your KeyStudio until you are instructed to connect it.

To install the drivers for KeyStudio:

1. Download the latest Windows XP driver for your KeyStudio from Support > Drivers/Updates at www.m-audio.com, then double-click the downloaded file.
2. Follow the driver installer's on-screen direction prompts.
3. At various points in this installation process, you may be notified that the driver being installed has not passed Windows Logo Testing. Click "Continue Anyway" to proceed with installation.
4. Click "Finish" when the driver installer has completed the driver installation.
5. Connect your KeyStudio to an available USB port using the cable provided.
6. Make sure that the power switch on the back of the keyboard is in the "on" position.
7. You will be asked if you want to search the Internet for a driver. Select "No, not this time" and click "Next."
8. Windows will display a Found New Hardware Wizard.
9. Choose "Install the software automatically," and click Next.
10. Follow the driver installer's on-screen direction prompts and click "Finish" when the installer has completed KeyStudio installation.



2. Install the Session Music Creation Software.

PLEASE NOTE: Do not connect your M-Audio Micro audio interface to your computer until the Session software has been installed. Leave your Micro disconnected until instructed to connect it.

1. Insert the M-Audio Session DVD-ROM into your computer's DVD-ROM drive.
2. The computer will automatically display the install screen. If your computer fails to launch the installer, manually start it by clicking on Start > My Computer and double-clicking Session.
3. Follow the software installer's on-screen direction prompts.
4. Session comes with a large library of loops and instrument samples for music creation, known as Session Content. During the installation process, you will be asked if you would like to install this content, as well as the driver for the Micro audio interface. Make sure both of these check boxes remain selected. The M-Audio Micro driver and the Session content are required in order to gain access to all of Session's features.

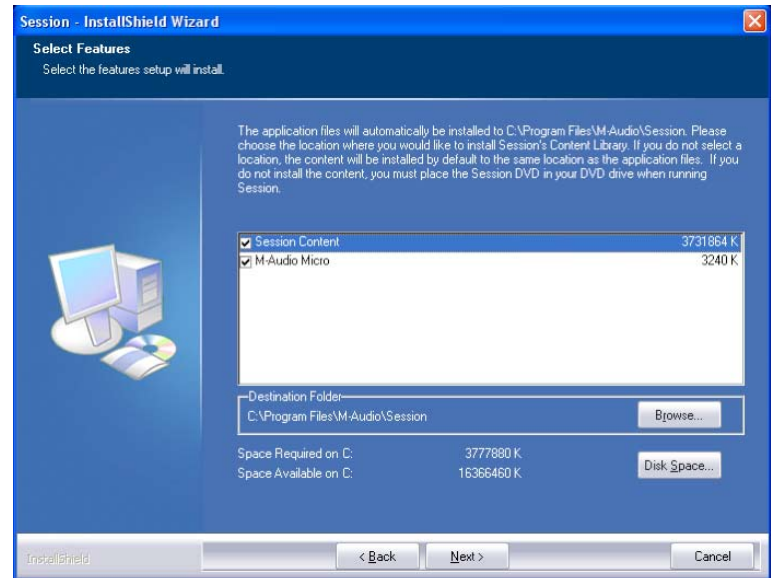

NOTE: Please be aware that your Session software's Factory Content Library may take as long as 30 minutes to install. This behavior is normal. During the installation process, the installer displays helpful Session tutorial information.

5. At various points in this installation process, you may be notified that the driver being installed has not passed Windows Logo Testing. Click "Continue Anyway" to proceed with the installation.
6. Click "Finish" once the installer has completed the installation.

3. Connect the M-Audio Micro USB Audio Interface.

1. Connect the M-Audio Micro USB audio interface to an available USB port on your computer. Upon installation, you may be prompted with a Windows Logo testing message. Click Continue Anyway.
2. Right-click the red M-Audio icon in the system tray and select Open M-Audio Micro control panel to access the Micro control panel. Here you can adjust input gain, monitor mix levels, output volume, and buffer size (latency). The control panel also shows details about the installed driver version.



Getting Started Making Music with Session

7

1. Double-click the Session shortcut icon that was placed on your desktop during installation. If this icon does not appear, go to Start > All Programs > M-Audio > Session > Session to open the application.



2. Click the button labeled "New" in the Session Startup window

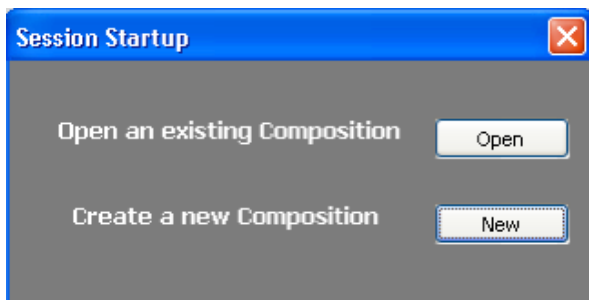

3. A New Composition dialog box will appear enabling you to choose a Name, Time Signature, Key Root, Key Scale, and Tempo for your composition. After these choices have been made, click OK.

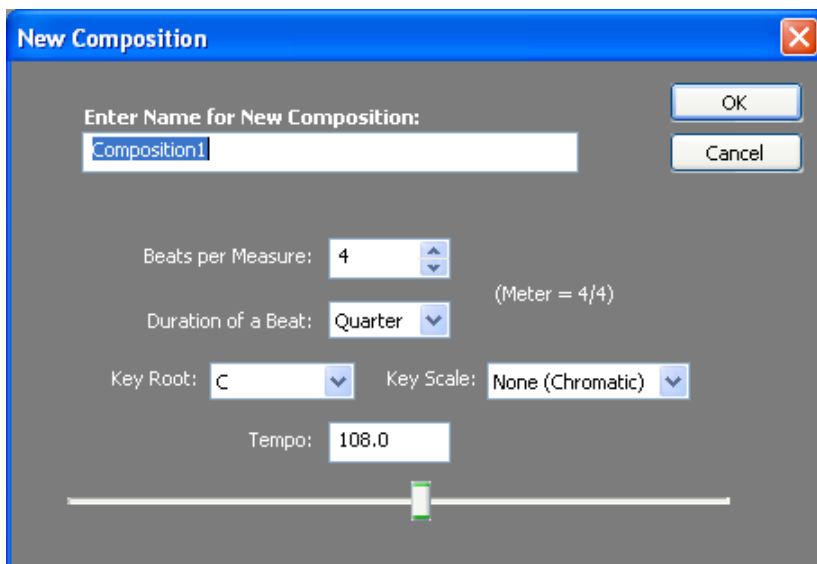

4. The “What would you like to do?” dialog box will now appear. For this example, select Play and Record with Your Keyboard, and click OK.

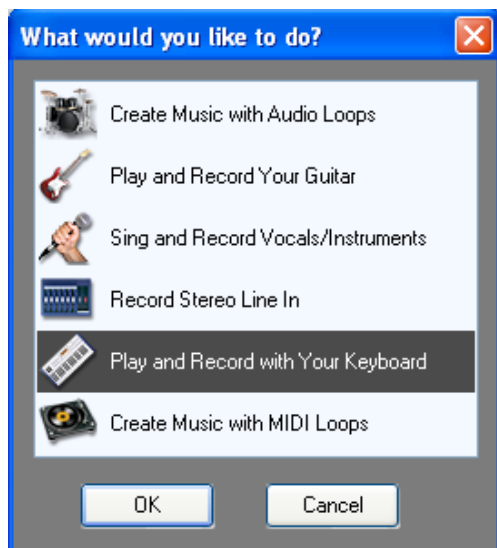

5. In the “Select Keyboard Sound” dialog box, select the bank of sounds you would like to associate with the first track of your new song, and click OK.

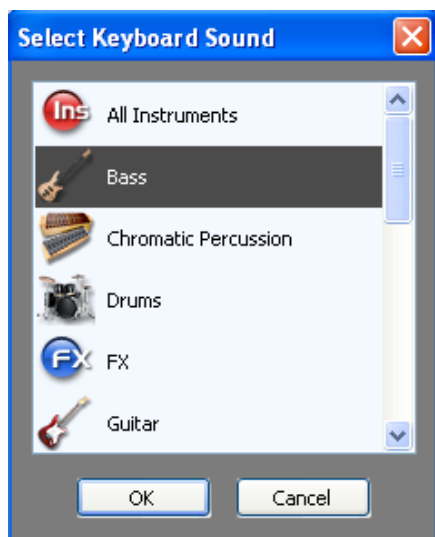

- The Session window will now appear. You may click the specific instrument you would like to play from the instrument list appearing on the left side of the screen.

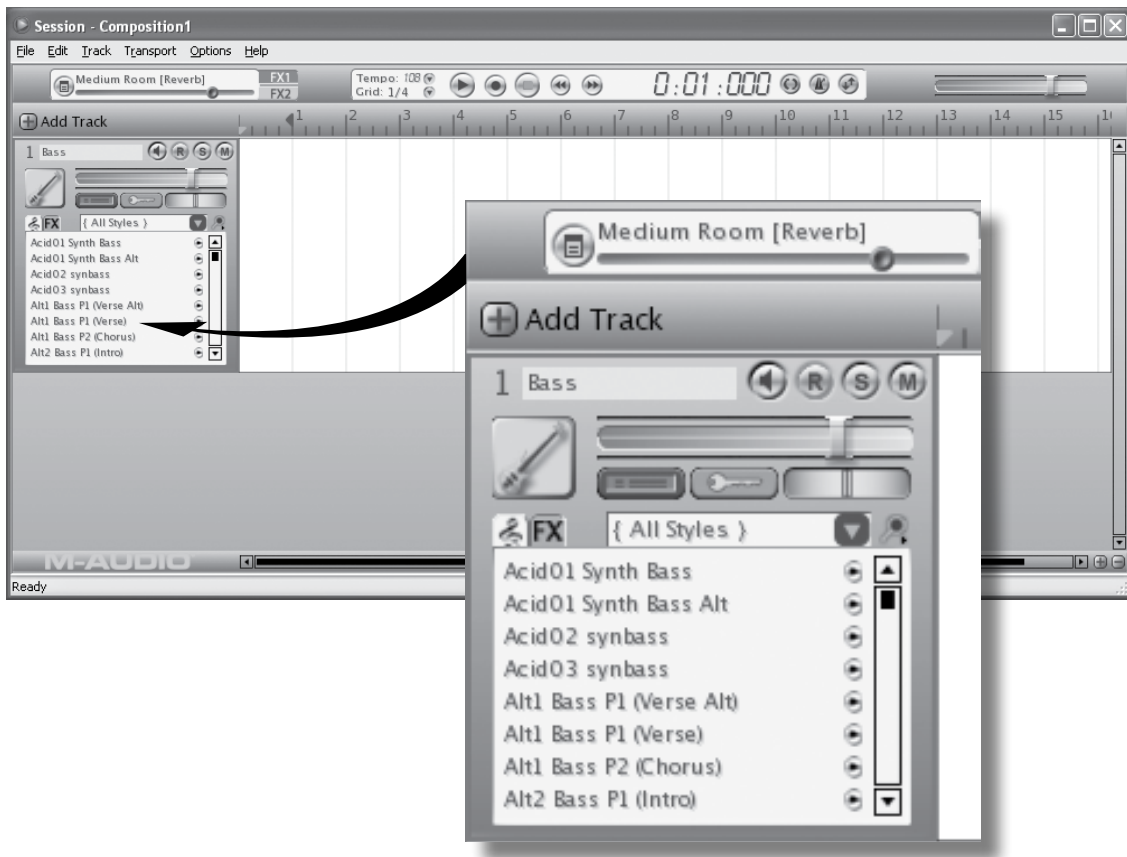

- Go to Options > Audio Hardware and make sure "ASIO: M-Audio USB ASIO" is selected in the Wave Device pull-down menu. Click OK.



- Go to Options > MIDI Hardware and make sure "USB Audio Device" or "KeyStudio In" is selected in the Input Port box. KeyStudio will appear as "USB Audio Device" (Figure A) if additional drivers have not been installed. After installing optional drivers, KeyStudio will appear as "KeyStudio In" (Figure B).



Figure A



Figure B

Figure A: Session's MIDI Devices dialog window without optional drivers installed.

Figure B: Session's MIDI Devices dialog window with optional drivers installed.

- Select the instrument track you wish to play. You should now be able to use your KeyStudio keyboard to play instruments from Session's vast instrument library.

NOTE: Your Speakers or Headphones need to be connected to M-Audio Micro's output in order to hear the sounds Session generates.

The series of steps just described illustrates the following concept: Session software contains the sounds that the KeyStudio keyboard controls.

If you are new to MIDI (Musical Instrument Digital Interface), you may find it challenging to understand why sounds have not simply been included in the keyboard. You will find that using a software-based sound source and recording system allows for access to an extremely large array of high quality sounds, a large graphic user interface, and freedom to work with many music creation applications. A basic understanding of MIDI will enable you to take advantage of its wealth of creative possibilities.

MIDI data gives instructions on how a sound should play. These instructions dictate parameters such as what note to play, when to play it, how loud to play it, and which sound to use. State of the art music applications, such as the Session software, contain virtual instruments that are capable of generating sound when MIDI data is sent to them. Data from the KeyStudio keyboard is transmitted to the sequencer program (e.g. Session), routed to a virtual instrument, and sent to an audio output, turning MIDI data into audible sounds. Much of this process is conveniently automated through prompting when you use Session. For more information on Session, such as recording audio and using loops, see the Session User Guide available from the Session Help menu.

The KeyStudio Keyboard

8

Key Names

The letters printed above the white keys stand for the names of the musical notes the keys represent. The number next to each letter marks the octave each key belongs to. (More information on octaves can be found in the following section.) Black keys are “semitones” to their adjacent white keys and don't have a dedicated letter. A semitone represents the distance in pitch from one note to its immediate neighbor.

Black keys usually have the same name as the next higher or lower white key, but have an additional sharp symbol (# – semitone higher than the letter indicates), or flat symbol (b – semitone lower than the letter indicates) attached to them. For example, the name of the black key to the right of C3 is C#3 (C-sharp 3), but it can also be called Db3 (D-flat 3), since it is also adjacent to the D key on its right. In other words, black keys have two valid names, depending on the context of the musical notation they are part of.

Octave Buttons

An octave contains 12 notes, and each octave is marked out clearly on your KeyStudio keyboard by black and white sections starting on C. Each octave is given a number.

KeyStudio is able to shift the pitch of its keys up or down by one or more octaves. When the keyboard's octaves are not shifted (octave shift set to zero), the lights above both the Octave “<” and Octave “>” buttons will be lit. The default octave shift designation is zero and will be the octave setting each time you power up the keyboard.

If you press the Octave “>” button once, the light above the Octave “<” button will go out, indicating the keyboard is now playing an octave higher. If you press the Octave “>” button again, the keyboard will be shifted up two octaves. It is possible to shift the keyboard up a total of four octaves using the Octave “>” button. To shift the octave down, press the Octave “<” button in the same manner: pressing once for one octave, twice for two octaves, and three times for three octaves. It is possible to shift the keyboard down a total of three octaves.

To return the keyboard's octave shift to zero, press both the Octave “<” and “>” buttons at the same time. Both LEDs will light, indicating that the octave shift has returned to zero. In summary, when the Octave buttons are set to control octave shift (default), if the light is only lit above the Octave “>” key, the octave is shifted up. If the light is only lit above the Octave “<” key, the octave is shifted down.

Pitch Bend Wheel

As the name indicates, the Pitch Bend wheel is usually used to bend the notes played on the keyboard up or down. This allows you to play phrases not normally associated with keyboard playing, including guitar-style riffs. Your sound source determines how far you can bend the note. The usual setting is two semitones but can be up to two octaves up or down.

Modulation Wheel

The Modulation wheel is typically used for modulation of the sound you are playing. This real-time controller was originally introduced on electronic keyboard instruments to give the performer options such as adding vibrato, just like players of acoustic instruments do. KeyStudio's Modulation wheel is assignable to control many possible parameters. (See chapter “Advanced KeyStudio Features in Edit Mode” for more information on this.)

Volume Slider

The Volume slider can send MIDI messages that control the volume of the notes you are playing. The Volume slider can also be assigned to control different parameters such as pan (balance), attack, reverb, and chorus. (See chapter “Advanced KeyStudio Features in Edit Mode” for more information on this.) Some software applications respond to volume control MIDI messages, and some programs (like M-Audio's Session) utilize the mouse and graphic user interface to control the volume of instruments.

Sustain Pedal Jack

You can connect a momentary-contact foot pedal (not included) to the Sustain jack on the back of your M-Audio keyboard. The keyboard will automatically detect the correct polarity when powering up. If you want to reverse the polarity, simply press the pedal when you switch on your keyboard.

The foot pedal is normally used for sustaining the sound you are playing without having to keep your fingers pressing down the keys. This is similar to an acoustic piano's sustain pedal function.

Advanced KeyStudio Features in Edit Mode

9

The button to the left of the keys labeled “Edit Mode” is used to access additional advanced functions of the keyboard. When this button is pressed, the keyboard will enter Edit mode and the keys on the keyboard can be used to select functions and enter data.

The light above the Edit Mode button indicates whether or not the keyboard is in Edit mode. When in Edit mode, the black keys on the keyboard are used for selecting functions, while the white keys are used for data entry and channel selection.

Your keyboard will exit Edit mode as soon as either a function is selected or the CANCEL or ENTER key is pressed. The light above the Edit Mode button will then turn off and the keyboard can then be used to play notes again. Some functions do not require any additional data entry. When these functions are selected, the keyboard will automatically exit Edit mode and return to Performance mode.

Advanced Functions in Edit Mode

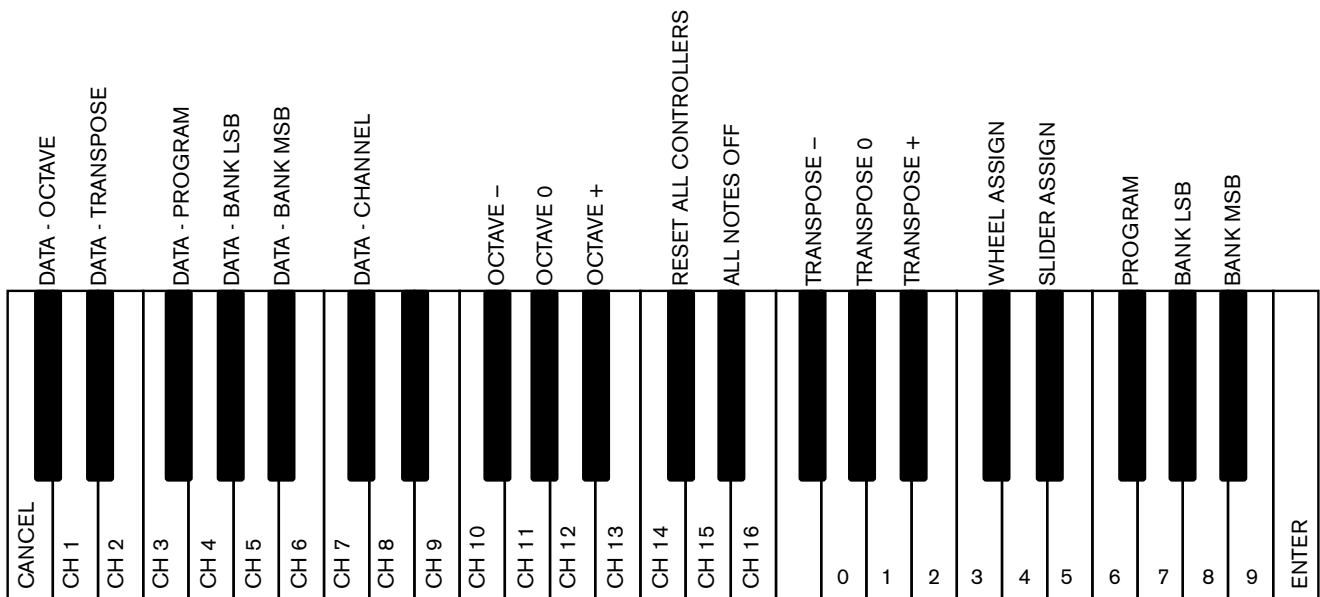

Octave Buttons Options

The Octave “<” and “>” buttons can be assigned to control one of six possible MIDI functions:

- Octave Shift
- Transpose
- Program Change
- Bank LSB
- Bank MSB
- MIDI Channel Change

In the diagram above, the first six black keys are labeled “DATA = OCTAVE, DATA = TRANSPOSE, DATA = PROGRAM, DATA = BANK LSB, DATA = BANK MSB, and DATA = CHANNEL.” These keys are used to select the desired alternate function of the Octave buttons.

To select an alternate function:

1. Press the Edit Mode button.
2. Press the black key that represents the function you want to assign to the Octave buttons. KeyStudio will exit Edit mode as soon as you push one of these keys.

PLEASE NOTE: Some of the functions that the Octave buttons can be used for cannot send out a value less than zero. When used to control these functions, both lights above the buttons will remain on, regardless of the current setting of that function.

The available functions of the octave buttons are:

Octave Shift

The Octave “<” and “>” buttons control octave shift by default. However, if these keys have been programmed to control another function, you may wish to re-assign them to control octave shift once again.

To assign the Octave “<” and “>” buttons to control octave shift:

1. Press the Edit Mode button.
2. Press the black key above C1 (C#1), representing DATA = OCTAVE. KeyStudio will exit Edit mode as soon as C#1 has been pressed.

• The OCTAVE “+” and “-” Keys

Another method of shifting KeyStudio’s octaves is with the use of the black keys labeled OCTAVE “+,” “-,” and “0” on the Advanced Functions in Edit Mode diagram. This octave shift method can be useful when the Octave buttons have been reassigned to control another MIDI function.

1. Press the Edit Mode button.
2. Press the black key below B2 (Bb2). In Edit mode, this key functions as “OCTAVE +,” shifting the keyboard up one octave. It is possible to shift the keyboard up a total of four octaves.
3. Press the black key above F2 (F#2). In Edit mode, this key functions as “OCTAVE -,” shifting the keyboard down one octave. It is possible to shift the keyboard down a total of three octaves.
4. Press the black key above G2 (G#2). In Edit mode, this key functions as “OCTAVE 0” to reset the octave shift to zero.
5. When you have chosen your octave shift, either press C5 representing “ENTER,” or press the Edit Mode button to exit Edit mode.

Transpose

In some cases it is useful to increase or decrease the transmitted pitch by a small number of semitones rather than a whole octave. For example, you may be playing a song with a singer and the singer is having trouble hitting the high notes. In this case, you can try reducing the pitch by one or more semitones. This is achieved using a function called "Transpose."

Transpose works similar to octave shift, except the shift is not limited to multiples of 12 semi-tones. As with octave shift, there are two ways of transposing the keyboard. When in Edit mode, you can assign the Octave "<" and ">" buttons to control the transpose feature. Alternatively, you can use the black keys F#3, G#3, and Bb3 to shift the transposition. These black keys represent "TRANSPOSE -," "TRANSPOSE 0" and "TRANSPOSE +" respectively.

To assign the Octave "<" and ">" buttons to transpose:

1. Press the Edit Mode button.
2. Press the black key above D1 (D#1), representing "DATA = TRANSPOSE." KeyStudio will exit Edit mode as soon as D#1 has been pressed.

When the Octave buttons are assigned to transpose the keyboard, the lights above the buttons indicate the direction of the transposition. To return the keyboard's transpose shift to zero, press both the Octave "<" and ">" buttons at the same time.

Channel

MIDI data from the keyboard can be sent on any of 16 MIDI channels. KeyStudio's default is to transmit MIDI data on channel 1. However, certain MIDI performance or recording scenarios may require the keyboard to send data on a different channel. You can change the channel on which data is sent using the following method:

1. Press the Edit Mode button.
2. Press one of the 16 channel keys from D1 to E3, whichever one represents the channel you need. KeyStudio will exit Edit mode as soon as a channel key has been pressed.

For example, if a device specifies that you need to send data on channel 10, press the Edit Mode button, and then F2 to select channel 10. This channel is usually dedicated to drum sounds when working with GM compatible synthesizers and sound modules.

The channel can also be assigned to the Octave "<" and ">" buttons by pressing the Edit Mode button and then C#2. This will allow the Octave "<" and ">" buttons to increment or decrement through the channels. When channel 16 is reached and ">" is pressed, channel 1 will be selected. If the Octave "<" and ">" keys are assigned to vary the channel, the lights above the buttons will not change, since it is not possible to have a channel with a negative value. Pressing both the "<" and ">" buttons together will recall KeyStudio's default, channel 1.

Program Change

Program changes are used to change the instrument or voice you are controlling with your KeyStudio. Program change messages are not needed when working with Session, but can be beneficial when using the KeyStudio keyboard to control MIDI sound modules or synthesizers. For example, let's change the instrument on a General MIDI sound module to a cello sound. To do this we need to send a program change of 42, which will select a cello sound from the General MIDI Instruments standard list (see *Appendix A*). There are two methods to send the program change:

1. Increment/Decrement Program Change:

1. Press the Edit Mode button.
2. Press the black key above F1 (F#1). Now the Octave "<" and ">" keys can be used to change the program.

2. Quick Select Program Change

1. Press the Edit Mode button.
2. Press the black key above F4 (F#4), representing "program."
3. Press keys D4, then B3, then C5. This enters the combination: "4," "2," "ENTER."

Now the keyboard is set to play the GM cello sound 42 (from the General MIDI Instruments standard list). The full list of General MIDI program numbers is given in *Appendix A* at the end of this manual.

Method 1 is useful if you want to cycle through different instruments for the purpose of comparing and choosing which sound works best in your song. Method 2 is more useful if you want to select a specific sound patch, as is the case here.

If the Octave "<" and ">" buttons have been assigned to control the program number (Method 1), the lights above the buttons will not change, since it is not possible to have a program with a negative value. Pressing both the "<" and ">" buttons together will recall Program 0, which selects the first sound patch on any synthesizer capable of processing MIDI program changes.

Bank LSB and Bank MSB

Program changes are the most commonly used messages to change instruments and voices. However, the number of instruments accessible using only the program change MIDI command is limited to 128. Since some devices have more than 128 voices, they require a method to organize their large number of sounds into banks. These devices then access the sounds within these banks by using program change messages. See chapter 11, "MIDI Messages Explained" for additional information. Generally, these devices use Bank LSB (Least Significant Byte) and Bank MSB (Most Significant Byte) change messages. KeyStudio can send these bank change messages in two possible ways*:

1. Incremental/Decremental Bank LSB and Bank MSB Change:

1. Press the Edit Mode button.
2. Press the black key above G1 (G#1) or Bb1 (A#1). Now the Octave "<" and ">" keys can be used to change Bank LSB or Bank MSB.

2. Using the Quick Select Method:

1. Press the Edit Mode button.
2. Press the black key above G4 (G#4), or Bb4 (A#4), representing Bank LSB or Bank MSB respectively.
3. Press keys C4, then B3 then C5. This enters the combination: "3," "2," "ENTER."

As with Program changes, if the Octave "<" and ">" buttons are selected to vary the Bank LSB or MSB number (Method 1), the lights above the buttons will not change, since it is not possible to have a Bank with a negative value. Pressing both the "<" and ">" buttons together will recall Bank 0.

***Note:** Bank change messages must be followed by a program change message in order to recall a sound. Bank change message by themselves do not activate a sound, but only locate and access a predefined location of a set (bank) of 128 sounds.

Other Assignable Controllers on KeyStudio

10

The Modulation Wheel

It is possible to assign different MIDI controller numbers to the Modulation wheel. These parameters are called MIDI continuous controllers. There are 132 (counting from and including zero to 131) MIDI continuous controllers (MIDI CC's). For these controller values to have any effect on the sound, the receiving software or device has to be able to read and respond to these MIDI controller messages. KeyStudio accepts controller numbers 0-131. Numbers beyond 127 are a proprietary method M-Audio uses to simplify the transmission of certain, otherwise more complicated multi-part MIDI messages. A full list of controller values is given at the back of this manual in *Appendix B*.

Some useful MIDI CC's are:

- 01 Modulation
- 07 Volume
- 10 Pan (balance)
- 05 Portamento

To assign a MIDI controller message to the Modulation wheel:

1. Press the Edit Mode button.
2. Press the black key above C4 (C#4), representing "WHEEL ASSIGN."
3. Use the Numerical Data Entry keys G3 – B4 to enter the number of the MIDI controller you want to assign to the Modulation wheel.
4. Press the ENTER key (C5).
5. Move the Modulation wheel upwards to increase the value of the MIDI message sent.

If you make an error while entering the numerical data value, you can press the CANCEL key (C1) to exit Edit mode without changing the MIDI CC assigned to the Modulation wheel.

As an example, let's assign effect number 10 to the Modulation wheel. This means the Modulation wheel will control Pan (or balance). To do this, we need to:

1. Press the Edit Mode button.
2. Press the black key above C4 (C#4), representing "WHEEL ASSIGN."
3. Press A3 to enter "1."
4. Press G3 to enter "0" so you have entered "10."
5. Press C5 for "ENTER."

The Volume Slider

As with the Modulation wheel, the Volume slider can also be assigned to any of the 132 controllers (0-131) shown at the back of this manual.

To assign the Volume slider to a certain MIDI parameter:

1. Press the Edit Mode button.
2. Press the black key above D4 (D#4), representing "SLIDER ASSIGN."
3. Use the Numerical Data Entry keys G3 – B4 to enter the number of the controller value you want to assign to the Volume slider.
4. Press the ENTER key (C5).

If you make an error while entering the numerical data value, you can press the CANCEL key (C1) to exit Edit mode without changing the MIDI CC assigned to the Volume slider.

PLEASE NOTE: Each time the keyboard is turned off, optional MIDI parameters assigned to the Volume slider or Modulation wheel will be lost. Each time the keyboard is powered up, the Volume slider will default to being assigned to Volume (MIDI CC 07), and the Modulation wheel will default to being assigned to modulation (MIDI CC 01).

MIDI Messages In-Depth

11

Program & Bank Changes

When the MIDI standard was first established, it enabled the user to access only 128 different sounds using program change messages (0-127). As MIDI devices grew to be more sophisticated and contain more sounds, bank change messages were included in an updated MIDI specification to allow for more than 128 sounds to be accessed.

The language MIDI uses to communicate between musical instruments only allows for program change commands 0-127, for a total of 128 possible programs (127 programs + program "0" = 128 programs total). Because of inherent limitations of the MIDI communication protocol, the number of directly accessible programs (using program change messages) cannot easily be expanded beyond 128. Thus, a system of banks, with 128 sounds in each, has been created that enables manufacturers to overcome the 128-sound MIDI limit.

128 Banks with 128 sounds in each bank is the basic principle used to expand the number of accessible sounds. However, to avoid reaching the new limit of the resulting 16,384 possible sounds (128 banks x 128 programs) accessible using a bank change combined with a program change, another layer of banks was added. The result is a system of 128 banks that can contain 128 sub-banks in each of them, which, in turn, can contain 128 sounds (programs) within them.

Bank change messages are useful when calling up sounds from a large library that may exist in a particular sound module or software synth. For example devices that are built with Roland's GS specification or Yamaha's XG specification require you to specify a bank change in order to access the extra voices and effects that these devices provide.

MIDI CC 0 is the bank select MSB (Most Significant Byte) message. This MIDI message is 7-bit in size and can be used to select any of 128 banks. This message can be used in conjunction with MIDI CC 32 which is bank select LSB (Least Significant Byte): a separate 7-bit message allowing additional selection of any of another 128 sub-banks. The combination of Bank MSB and LSB messages gives a 14-bit message that can select any of a possible 16,384 banks. Each bank can in turn contain 128 possible sounds selected via a separate program change MIDI message. This enables a user to theoretically recall over two million programs directly, using only MIDI commands. However, most devices only use a few different banks, and you can often ignore the LSB message.

You will find many MIDI devices respond to program change commands and many are organized according to the GM listing. In General MIDI devices, different sounds are organized in the same way from device to device. Piano sounds are in their particular place, string sounds are in their place, drum sounds are in their place, and so on. All GM devices (both hardware and software sound modules) are clearly labeled as such, so you know that their sounds are organized in the General MIDI structure. When a GM device receives a MIDI program change, it calls up a type of sound that you expect from the GM sound set. All non-GM MIDI sound modules call up unique sounds from their memory upon receiving MIDI program changes. Since the sounds in a non-GM device are not arranged in a particular order, you need to take a look at the device itself to see which sound you want and at which location in the memory it resides. Many VST instruments such as Native Instruments' FM7 or the synth modules in Propellerhead Reason are non-GM devices.

You can send program change, bank LSB and bank MSB messages directly from the KeyStudio keyboard. Please consult the "Advanced KeyStudio Features in Edit Mode" section of this User Guide for further details.

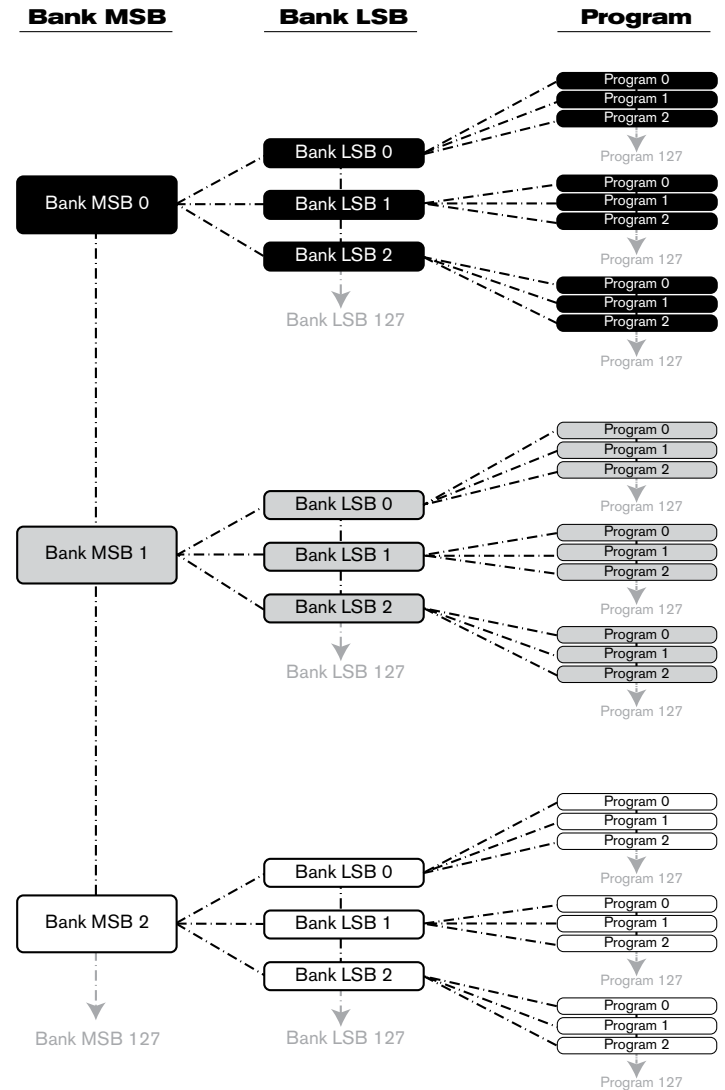

NRPN/RPNs

Non-registered parameter numbers (NRPN's) are device-specific messages that enable you to control synths and sound modules via MIDI. The MIDI specification defines open parameter numbers to allow manufacturers to specify their own controllers. The more common of these are registered by the MIDI Manufacturer's Association and are now part of the MIDI specification (hence the term Registered Parameter Numbers – RPN's). (See *Appendix B*) Each NRPN/RPN has an associated 2-byte number. The two bytes allow for 128 values each. (An RPN or NRPN message is made up of two parts: the MSB and the LSB message. Both of these messages together constitute an RPN or NRPN command.) This allows for 16,384 values in total.

MIDI controllers 98 and 99 represent the NRPN LSB and MSB respectively, while 100 and 101 represent the RPN LSB and MSB messages (see the MIDI controllers list in *Appendix B*). To transmit an NRPN/RPN message, these LSB and MSB controller messages are sent along with their user-specified values. A further controller message and value needs to be sent to specify the (coarse or fine) value adjustment. This is specified by controller number 6 (data entry) for coarse adjustments or number 38 for fine adjustments.

A list of NRPN's is usually given in the user's manual of any device that receives NRPN messages. It is always necessary that the NRPN MSB and LSB be sent together. Both will be specified in the device's manual.

Troubleshooting

12

Session KeyStudio has been tested in a wide range of systems and operating conditions. However, there are virtually limitless numbers of operating scenarios, any of which could affect your system's performance. Though this section cannot cover all possible situations you may encounter, we would like to offer some suggestions for dealing with possible problems. If you are still not able to find the answer you are looking for, please feel free to contact M-Audio technical support for further assistance.

Problem 1: My KeyStudio keyboard suddenly stopped working after having performed fine since installation.

Solution 1: Close any music applications you are using, switch the KeyStudio off, and restart your computer. Once your computer has completely restarted, switch the KeyStudio back on.

Problem 2: I have connected a sustain pedal to my M-Audio keyboard, but its function is reversed.

Solution 2: The polarity of the sustain pedal is calculated by the keyboard when it is powered up. On power up, the sustain pedal is assumed to be in the OFF position. If you want the sustain pedal to be off when it is not pressed, make sure the pedal is not pressed when you power up. Also check to see if there is a polarity switch on your foot pedal. It is possible to use this switch to change foot pedal polarity as well. Another way to reverse the sustain pedal's polarity is to keep it pushed while powering on your KeyStudio keyboard.

Problem 3: When I press a key, or attempt to monitor my microphone or instrument input, there is a noticeable delay before I hear any sound.

Solution 3: This delay is known as latency, and latency can be adjusted by changing the buffer size setting in your M-Audio Micro control panel. The goal is to set the buffer size as low as possible without experiencing artifacts in the audio. Faster computers generally allow for smaller buffer size settings, and thus less latency. If there is a large delay between what you play on the keyboard, and what you hear from your virtual instrument in Session, click Options > Audio Hardware > ASIO Settings > Latency, and drag the slider downwards.

Problem 4: I am attempting to play back audio from Session, and cannot hear sound from the Micro audio interface.

Solution 4: Make sure that your speakers or headphones are properly connected to the Micro, and not to your computer's built-in soundcard. Check the Micro control panel to make sure the volume is turned up and it is not muted. Open Session's Audio Hardware configuration dialog by choosing Options>Audio Hardware. Make sure that the Driver Type is set to ASIO, the selected Wave Device is "ASIO: M-Audio USB ASIO" and the M-Audio Micro is selected in the Output Channel box.

Problem 5: I am unable to input monitor through Session.

Solution 5: Click the Input Active button, enabling the Input Active feature. This allows you to play or sing through Session, otherwise known as input monitoring. Depending on the proximity of your microphone or guitar to your speakers, and the volume setting of your speakers, there is potential for feedback (a loud, screeching noise). Be sure to turn your speaker volume down before pressing the Input Active button. After pressing the Input Active button, gradually increase your speaker volume to a safe level. Optionally, Session can press the Input Active button automatically for the selected Track. This option is disabled by default to protect your ears and speakers. To turn this option on, select Auto Input Monitor Selected Audio Track from the Track menu, located at the top of the Session window.

Another option for input monitoring is to raise the Monitor Mix slider in the Micro control panel. This slider dictates how much of the Micro's input is sent directly to the Micro's output. This is direct, near-zero latency monitoring that is not affected by buffer size. The Micro control panel Monitor Mix option is accessed by clicking Options > Audio Hardware > ASIO Settings > Levels.

Problem 6: I hear a loud screeching sound after creating or selecting an audio track.

Solution 6: If you are using speakers, and your microphone is too close to the speakers, you may experience feedback. To solve this issue,

- Lower your speaker's volume.
- Disable Auto Input Monitor Selected Audio Track from the Track menu in the Menu bar. If you choose this option, make sure to press this button when you need to monitor through the track.

In general, it is good practice to turn your speakers off while recording, and listen with headphones.

Problem 7: I hear crackles, clicks, or pops when playing or recording audio.

Solution 7: Make sure that Session's Master Volume Control does not indicate clipping. This control indicates clipping by drawing two red dots at the far right edge of the volume meter. If you see clipping, move the Master Volume Control slider to the left. If you hear crackles, clicks, pops, or other artifacts while recording or input monitoring through a track, lower your microphone or guitar signal until the track stops clipping. Crackles, clicks, pops, or other artifacts also occur when your computer cannot keep up with the current task. To solve this problem in Session, click Options > Audio Hardware > ASIO Settings > Latency, and drag the slider upwards. Repeat this process if this problem continues.

Problem 8: The KeyStudio does not trigger sounds in Session.

Solution 8: Go To Options > MIDI Hardware and make sure "USB Audio Device" or "KeyStudio In" is selected in the Input Port box. Also make sure a track for keyboard playback and recording is selected.

Problem 9: I cannot locate the KeyStudio USB keyboard in my software's MIDI devices dialog box.

Solution 9: The KeyStudio requires a powered USB port. Try plugging the KeyStudio into a different USB port or powered USB hub connected to your computer.

Problem 10: My synthesizer always recalls the sound next to the program number that I have sent to it from the KeyStudio. For example, if I send a program change with the number 40 (Violin), my software loads sound number 41 (Viola).

Solution 10: Some General MIDI modules count their sound patches from 1 – 128 instead of 0-127. Both methods are common. As a result, and depending on the sound module you use, there may be an offset of +/-1 between the sent program change number and the recalled sound patch.

Problem 11: Synth Patches and MultiFX Presets do not load.

Solution 11: It is likely that you moved the Factory and/or User Content Folders. If you moved the Factory Content Folder, you can point Session to it by choosing Locate Factory Content Folder from the Options Menu. If you moved the User Content Folder, you can point Session to it by choosing Set User Content Folder from the Options Menu.

Problem 12: After adding more sample content, the new content does not display in the Track Browsers.

Solution 12: When manually adding new content to Session (copying new files into Session's Content Folders), you must re-scan the Content Library by choosing Re-Scan Content Categories from the Category Manager.

Problem 13: The Composition sounds distorted.

Solution 13: If your Composition sounds distorted, you may need to lower the overall volume of the Composition by adjusting the Master Volume Control, located at the top right of the Session window. If the level is loud enough to cause distortion, you will see two red dots at the far right end of the Master Volume Control.

Problem 14: The Session software operates very slowly, and is very system-resource intensive.

Solution 14: This problem may be solved by downloading and installing a more current driver from your specific graphics card manufacturer's website.

Useful MIDI-specific Troubleshooting Features

13

Session KeyStudio has been designed to make working with MIDI on your computer as simple as possible. However, sometimes things can go wrong. To counter this, there are two useful MIDI functions.

All Notes Off

Use this if you find there are sustaining notes that you cannot stop. To send an “All Notes Off” MIDI message:

1. Press the Edit Mode button.
2. Press the black key above D3 (D# 3), representing “ALL NOTES OFF.”
3. Edit mode will exit, and there will no longer be any sustaining notes.

Reset All Controllers

If one or more of the loaded sound patches doesn't sound as expected, then it may mean that a MIDI CC has applied an undesired effect or other type of sound modulation to that voice. If you are unsure of which MIDI controller to adjust to eliminate the effect, you can send a “Reset All Controllers” MIDI message to set all controller values to their defaults. To send a Reset All Controllers message:

1. Press the Edit Mode button.
2. Press the black key above C3 (C# 3), representing “RESET ALL CONTROLLERS.”
3. Edit mode will exit, and all controller values will be reset to their default values.

Warranty Terms and Registration

14

Warranty Terms

M-Audio warrants products to be free from defects in materials and workmanship, under normal use and provided that the product is owned by the original, registered user. Visit www.m-audio.com/warranty for terms and limitations applying to your specific product.

Warranty Registration

Immediately registering your new M-Audio product entitles you to full warranty coverage and helps M-Audio develop and manufacture the finest quality products available. Register online at www.m-audio.com/register to receive FREE product updates and for the chance to win M-Audio giveaways.

Technical Info

15

Caution: Electro Static Discharge, Electrical Fast Transient and Conducted RF interference may cause the unit malfunctioning. In such case, unplug the unit and plug it in again to restore normal operation.

Note: Your M-Audio product has been tested to comply with FCC Standards FOR HOME OR OFFICE USE. Modifications not authorized by the manufacturer may void user's authority to operate this device.

Note: This equipment has been tested and found to comply with the limits for a Class B digital device, pursuant to Part 15 of the FCC Rules. These limits are designed to provide reasonable protection against harmful interference in a residential installation. This equipment generates, uses and can radiate radio frequency energy and, if not installed and used in accordance with the instructions, may cause harmful interference to radio communications. However, there is no guarantee that interference will not occur in a particular installation. If this equipment does cause harmful interference to radio or television reception, which can be determined by turning the equipment off and on, the user is encouraged to try to correct the interference by one or more of the following measures:

- Re-orient or relocate the receiving antenna.
- Increase the separation between the equipment and receiver.
- Connect the equipment to an outlet on a circuit different from that to which the receiver is connected.
- Consult the dealer or an experienced radio/ TV technician for help.

ASIO is a trademark of Steinberg Soft- und Hardware GmbH.

VST is a trademark of Steinberg Soft- und Hardware GmbH

WARNING: This product contains chemicals, including lead, known to the State of California to cause cancer, and birth defects or other reproductive harm. **Wash hands after handling.**

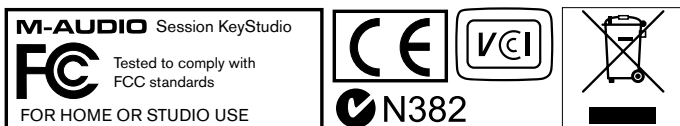

© 2007 Avid Technology, Inc. All rights reserved. Product features, specifications, system requirements and availability are subject to change without notice. Avid, M-Audio, Micro and Session KeyStudio are either trademarks or registered trademarks of Avid Technology, Inc. All other trademarks contained herein are the property of their respective owners.

Appendices - Useful MIDI Data

16

Appendix A - General MIDI Instruments

PLEASE NOTE: The following table lists all General MIDI patch names using numbers from 0 – 127. Be advised that some GM modules count their sound patches from 1 – 128 instead. Both methods are common. As a result, and depending on the sound module you use, there may be an offset of -1 between the sent program change number and the recalled sound patch.

Piano	Bass	Reed	Synth Effects
0 Acoustic Grand Piano	32 Acoustic Bass	64 Soprano Sax	96 SFX Rain
1 Bright Acoustic Piano	33 Electric Fingered Bass	65 Alto Sax	97 SFX Soundtrack
2 Electric Grand Piano	34 Electric Picked Bass	66 Tenor Sax	98 SFX Crystal
3 Honky Tonk Piano	35 Fretless Bass	67 Baritone Sax	99 SFX Atmosphere
4 Electric Piano 1	36 Slap Bass 1	68 Oboe	100 SFX Brightness
5 Electric Piano 2	37 Slap Bass 2	69 English Horn	101 SFX Goblins
6 Harpsichord	38 Syn Bass 1	70 Bassoon	102 SFX Echoes
7 Clavinet	39 Syn Bass 2	71 Clarinet	103 SFX Sci-Fi
Chromatic Percussion	Strings/ Orchestra	Pipe	Ethnic
8 Celesta	40 Violin	72 Piccolo	104 Sitar
9 Glockenspiel	41 Viola	73 Flute	105 Banjo
10 Music Box	42 Cello	74 Recorder	106 Shamisen
11 Vibraphone	43 Contrabass	75 Pan Flute	107 Koto
12 Marimba	44 Tremolo Strings	76 Bottle Blow	108 Kalimba
13 Xylophone	45 Pizzicato Strings	77 Shakuhachi	109 Bag Pipe
14 Tubular bells	46 Orchestral Harp	78 Whistle	110 Fiddle
15 Dulcimer	47 Timpani	79 Ocarina	111 Shanai
Organ	Ensemble	Synth Lead	Percussive
16 Drawbar Organ	48 String Ensemble 1	80 Syn Square Wave	112 Tinkle Bell
17 Percussive Organ	49 String Ensemble 2 (Slow)	81 Syn Sawtooth Wave	113 Agogo
18 Rock Organ	50 Syn Strings 1	82 Syn Calliope	114 Steel Drums
19 Church Organ	51 Syn Strings 2	83 Syn Chiff	115 Woodblock
20 Reed Organ	52 Choir Aahs	84 Syn Charang	116 Taiko Drum
21 Accordion	53 Voice Oohs	85 Syn Voice	117 Melodic Tom
22 Harmonica	54 Syn Choir	86 Syn Fifths Sawtooth Wave	118 Syn Drum
23 Tango Accordion	55 Orchestral Hit	87 Syn Brass & Lead	119 Reverse Cymbal
Guitar	Brass	Synth Pad	Sound Effects
24 Nylon Acoustic	56 Trumpet	88 New Age Syn Pad	120 Guitar Fret Noise
25 Steel Acoustic	57 Trombone	89 Warm Syn Pad	121 Breath Noise
26 Jazz Electric	58 Tuba	90 Polysynth Syn Pad	122 Seashore
27 Clean Electric	59 Muted Trumpet	91 Choir Syn Pad	123 Bird Tweet
28 Muted Electric	60 French Horn	92 Bowed Syn Pad	124 Telephone Ring
29 Overdrive	61 Brass Section	93 Metal Syn Pad	125 Helicopter
30 Distorted	62 Syn Brass 1	94 Halo Syn Pad	126 Applause
31 Harmonics	63 Syn Brass 2	95 Sweep Syn Pad	127 Gun Shot

Appendix B - Standard MIDI Controller Numbers (MIDI CC's)

00 Bank Select	38 Data Entry LSB	76 Controller 76	114 Controller 114
01 Modulation	39 Channel Volume LSB	77 Controller 77	115 Controller 115
02 Breath Control	40 Balance LSB	78 Controller 78	116 Controller 116
03 Controller 3	41 Controller 41	79 Controller 79	117 Controller 117
04 Foot Control	42 Pan LSB	80 Gen Purpose 5	118 Controller 118
05 Porta Time	43 Expression LSB	81 Gen Purpose 6	119 Controller 119
06 Data Entry	44 Controller 44	82 Gen Purpose 7	Channel Mode Messages:
07 Channel Volume	45 Controller 45	83 Gen Purpose 8	120 All Sound off
08 Balance	46 Controller 46	84 Portamento Control	121 Reset all Controllers
09 Controller 9	47 Controller 47	85 Controller 85	122 Local Control
10 Pan	48 Gen Purpose 1 LSB	86 Controller 86	123 All Notes Off
11 Expression	49 Gen Purpose 2 LSB	87 Controller 87	124 Omni Off
12 Effects Controller 1	50 Gen Purpose 3 LSB	88 Controller 88	125 Omni On
13 Effects Controller 2	51 Gen Purpose 4 LSB	89 Controller 89	126 Mono On (Poly Off)
14 Controller 14	52 Controller 52	90 Controller 90	127 Poly On (Mono Off)
15 Controller 15	53 Controller 53	91 Reverb Depth	Extra RPN Messages:
16 Gen Purpose 1	54 Controller 54	92 Tremelo Depth	128 Pitch Bend sensitivity
17 Gen Purpose 2	55 Controller 55	93 Chorus Depth	129 Fine Tune
18 Gen Purpose 3	56 Controller 56	94 Celeste (De- tune)	130 Coarse Tune
19 Gen Purpose 4	57 Controller 57	95 Phaser Depth	131 Channel Pressure
20 Controller 20	58 Controller 58	96 Data Increment	
21 Controller 21	59 Controller 59	97 Data Decrement	
22 Controller 22	60 Controller 60	98 Non- Reg Param LSB	
23 Controller 23	61 Controller 61	99 Non- Reg Param MSB	
24 Controller 24	62 Controller 62	100 Reg Param LSB	
25 Controller 25	63 Controller 63	101 Reg Param MSB	
26 Controller 26	64 Sustain Pedal	102 Controller 102	
27 Controller 27	65 Portamento	103 Controller 103	
28 Controller 28	66 Sostenuto	104 Controller 104	
29 Controller 29	67 Soft Pedal	105 Controller 105	
30 Controller 30	68 Legato Pedal	106 Controller 106	
31 Controller 31	69 Hold 2	107 Controller 107	
32 Bank Select LSB	70 Sound Variation	108 Controller 108	
33 Modulation LSB	71 Resonance	109 Controller 109	
34 Breath Control LSB	72 Release Time	110 Controller 110	
35 Controller 35	73 Attack Time	111 Controller 111	
36 Foot Control LSB	74 Cut- off Frequency	112 Controller 112	
37 Porta Time LSB	75 Controller 75	113 Controller 113	

Appendix C - Additional RPN Messages

You may have noticed that although we have stated there are 128 MIDI controller messages (0 – 127), Appendix B shows 132 assignable controller messages. This is because messages 128 – 131 are a different type of MIDI message, defined in the MIDI Specification as RPN messages. M-Audio has created four messages that are sent like MIDI CCs, but actually transmit a series of RPN messages. This makes sending these complex multi-part messages as easy as sending a MIDI CC message. You can assign these to the controls on your KeyStudio keyboard in exactly the same way as any other MIDI controller message. The RPN messages control the following:

Controller Number	MIDI Message	Use
128	Pitch Bend Sensitivity	Alters the range of a pitch bend message
129	Master Tune (coarse)	Adjusts the tuning of your sound module or synthesizer in large steps
130	Master Tune (fine)	Adjusts the tuning of your sound module or synthesizer in small steps
131	Monophonic Aftertouch*	Adds a vibrato effect

*Monophonic aftertouch is not an RPN message. However, it is an additional effect message defined in the General MIDI specification and this is why we have included it in *Appendix C*.

M-Audio USA 5795 Martin Rd., Irwindale, CA 91706	
Technical Support	
web:	www.m-audio.com/tech
tel (pro products):	(626) 633-9055
tel (consumer products):	(626) 633-9066
fax (shipping):	(626) 633-9032
Sales	
e-mail:	sales@m-audio.com
tel:	1-866-657-6434
fax:	(626) 633-9070
Web	www.m-audio.com

M-Audio U.K. Floor 6, Gresham House, 53 Clarendon Road, Watford WD17 1LA, United Kingdom	
Technical Support	
e-mail:	support@maudio.co.uk
tel:(Mac support):	+44 (0)1765 650072
tel:(PC support):	+44 (0)1309 671301
Sales	
tel:	+44 (0)1923 204010
fax:	+44 (0)1923 204039
Web	www.maudio.co.uk

M-Audio France Floor 6, Gresham House, 53 Clarendon Road, Watford WD17 1LA, United Kingdom	
Renseignements Commerciaux	
tel :	0 810 001 105
e-mail :	info@m-audio.fr
Assistance Technique	
PC :	0 820 000 731
MAC :	0 820 391 191
Assistance Technique	
e-mail :	support@m-audio.fr mac@m-audio.fr
fax :	+33 (0)1 72 72 90 52
Site Web	www.m-audio.fr

M-Audio Germany Kuhallmand 34, D-74613 Ohringen, Germany	
Technical Support	
e-mail:	support@m-audio.de
tel	+49 (0)7941 - 9870030
fax:	+49 (0)7941 98 70070
Sales	
e-mail:	info@m-audio.de
tel:	+49 (0)7941 98 7000
fax:	+49 (0)7941 98 70070
Web	www.m-audio.de

M-Audio Canada 1400 St-Jean Baptiste Ave. #150, Quebec City, Quebec G2E 5B7, Canada	
Technical Support	
e-mail:	techcanada@m-audio.com
phone:	(418) 872-0444
fax:	(418) 872-0034
Sales	
e-mail:	infocanada@m-audio.com
phone:	(866) 872-0444
fax:	(418) 872-0034
Web:	www.m-audio.ca

M-Audio Japan アビッドテクノロジー株式会社 エムオーディオ事業部 : 〒460-0002 愛知県名古屋市中区丸の内 2-18-10 Avid Technology K.K. : 2-18-10 Marunouchi, Naka-Ku, Nagoya, Japan 460-0002	
カスタマーサポート (Technical Support)	
e-mail :	win-support@m-audio.jp
e-mail (Macintosh 環境専用) :	mac-support@m-audio.jp
tel :	052-218-0859 (10:00~12:00/13:00~17:00)
セールスに関するお問い合わせ (Sales)	
e-mail:	info@m-audio.jp
tel:	052-218-3375
fax:	052-218-0875
Web:	www.m-audio.jp